

INSTRUCTIONS

Designer Roller Shade Installation

No Headbox

LuXout  **Shades**

DESIGNER ROLLER SHADE INSTALLATION INSTRUCTIONS (No Headbox)

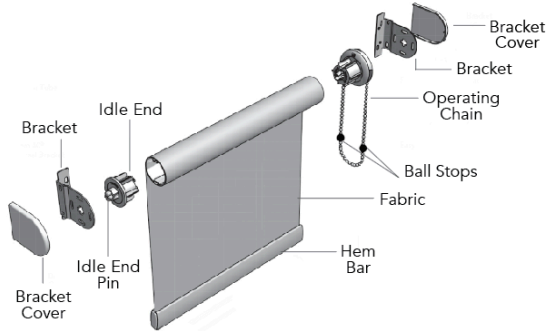

Thank you for placing your order with
LuXout Shades.

**Please read these installation instructions
before installation and carefully inspect all products
before disposing of the box.**

Getting Started

Carefully unpack your shades and check to make sure you have the following installation parts. We recommend reading through these instructions before starting the installation.

Parts Included:

- Screws (4)
- Mounting brackets (2)
- Tension Device (child safe)
- Bracket Covers (2)

Tools You Will Need:

- Drill with a 1/8" Drill Bit & Phillips Head Bit
- Phillips Screwdriver
- Metal Tape Measure
- Needle Nose Pliers

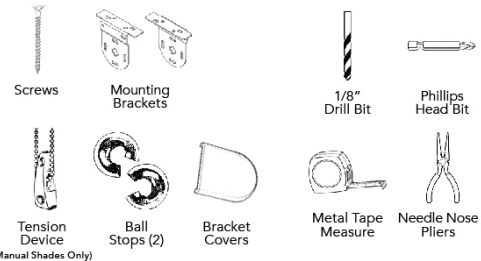

(Manual Shades Only)

Please note that your brackets must be securely attached to the mounting surface. If your screws do not hit wood studs, you may have to use a different fastener which can be found at any local hardware store.

- * According to the Window Covering Manufacturers Association Inc., all labels must not be removed from the product.
- * To comply with child safety standards, all tension devices must be installed per the installation instructions provided in step 3.

1. Determine How You Want to Install: Inside (A) or Outside Mount (B)

There are 6 easy ways to install brackets.
Choose which is best suited for your situation.

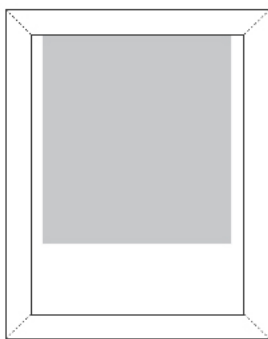

Inside Mount
A

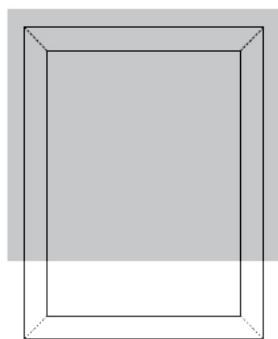

Outside Mount
B

Attach the brackets to the window frame, window molding, wall or ceiling, as shown in **Steps 1A** and **1B**. Brackets are universal so control may be mounted on either side. It should be noted however, that shade is made to be one side or other as ordered.

1A. Installing Brackets

Inside Mount

Option #1

1A.1 To mount through side or top of bracket, pre-drill marked indentations using 1/8" bit then install screws to secure.

Option #2

1A.2 With bracket in place, drill screws into window jamb through pre-drilled holes to secure.

Option #3

1A.3 For windows that do not have enough depth to install the bracket completely inside the window, position bracket straight on and install screws into side through pre-drilled holes.*

*BE SURE TO PUT BRACKET COVERS ON PRIOR TO INSTALLING

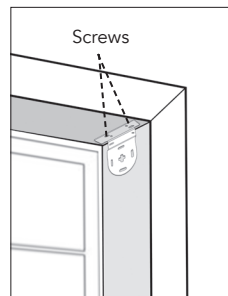

JAMB MOUNT
UPWARD

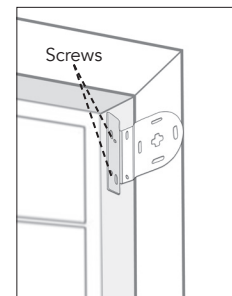

MOUNT
ON FRAME

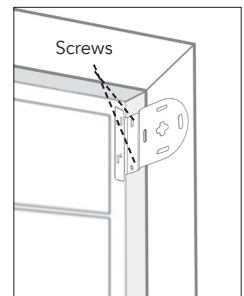

SIDE JAMB
MOUNT

INSTRUCTIONS

Designer Roller Shade Installation

No Headbox

1B. Installing Brackets Outside Mount

- Fit the shade into the brackets and center the shade over the window (this may take two people).
- With a pencil, mark the wall on the side of one bracket. Remove shade and then attach the one bracket with two screws.
- Next, insert the shade into the second bracket. Hold shade up and insert other end into the already mounted bracket making sure that the shade is level.
- Mark the wall on the side of the second bracket. Remove shade, install second bracket with two screws.

With bracket in place, drill screws through pre-drilled holes to secure.

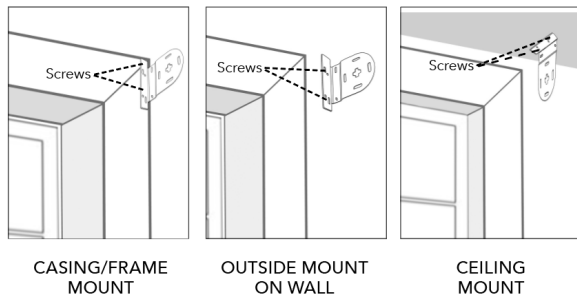

Proceed to Step 2

2. Inserting Shade in Bracket

With the brackets now installed, you may install your shade.

Step 2A:

Put the spring loaded idle end pin into the cross (+) hole of the bracket. Pushing the pin end towards its bracket, insert the outer hook on the operator side straight into the (+) slots in the opposite bracket.

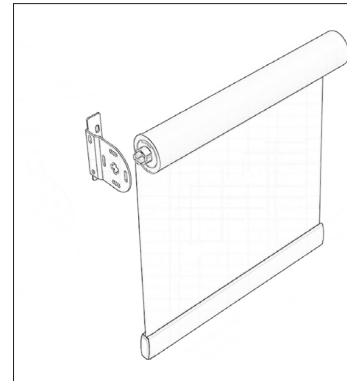

Step 2B:

Once the center hook is through the (+) slot, gently pull down on the operator until the hook has locked securely to the bracket.

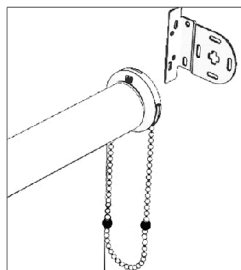

Step 2C:

Snap bracket covers on mounting brackets.

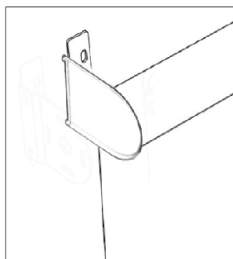

*** Please Note:** Roller shades are not meant to be lowered past the ordered length. The shade will come with additional material that is automatically added in length to conceal the roller tube and to help secure the fabric on the roll. **We have included metal ball stops** for the chain to be added by your installer to set shade limits and prevent the shade from being raised or lowered past its limits.

3. Finishing the Install

3A. Manual Chain Operated Shade

With the shade now installed, mount the chain tensioner.

- Mount the chain tension device (refer to separate instructions provided with the chain tension device). (see fig. 3A.1)
- Pull the chain to move the shade to be desired closed position (Note the side being pulled).
- On the opposite side, place a ball stop on the bead closest to the clutch. Use needle nose pliers to clamp ball stop in place.
- Pull the chain to move the shade to the desired open position (note the side that is being pulled).

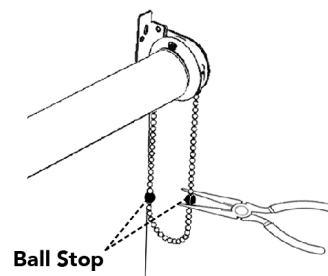

- On the opposite side, place a ball stop on the bead closest to the clutch. Use needle nose pliers to clamp ball stop in place.

INSTRUCTIONS

Designer Roller Shade Installation

No Headbox

3A.1 Installing the Tension Device (Continuous Loop Control)

Consider Position of Tension Device:

The tension device should be positioned on the window frame or the wall so that the tension device and bead chain do not interfere with operation of window treatment.

- The tension device should be installed so that bead chain is taut without stretching or pulling down on it.
- Stretching the bead chain will cause excessive wear.
- Do not twist or cross the bead chain.

Please refer to Chain Tension Device Installation Instructions (included)

fig. 3A.1



Tension Device

3B. Finishing the Install Motorized Shade

With the shade now installed, you may check the preset limits of your shade.

Note: Initial limits have been set in factory. Use the motor controller instructions to fine tune.

- Please refer to the separate motor instructions that are specific to your motor.
- Power-up the motor if not a rechargeable battery motor. Rechargeable battery motors are charged in the factory.
- Set the upper and lower limits to desired levels if not already set correctly or need adjustment.
- Setup motor shade controls. (Initial setup is done at the factory with each shade in a room assigned to a different channel for individual control or grouped as you select. Each channel has a blue LED light. All shades with an LED light will operate when using the controller.)

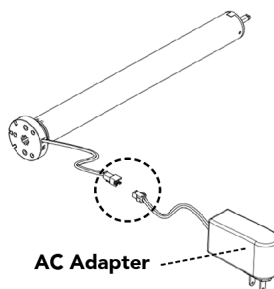

See channel guide for
each controller.

3C. Finishing the Install One Touch Wand Shade

With the shade now installed, you may check preset limits of your shade.

Note: Initial limits have been set in factory. Use instructions to fine tune.

- Attach the battery pack to the motor.
- Please refer to the separate One Touch Wand motor instructions.
- To adjust the limit settings, see specific motor instructions for the One Touch Wand motor.

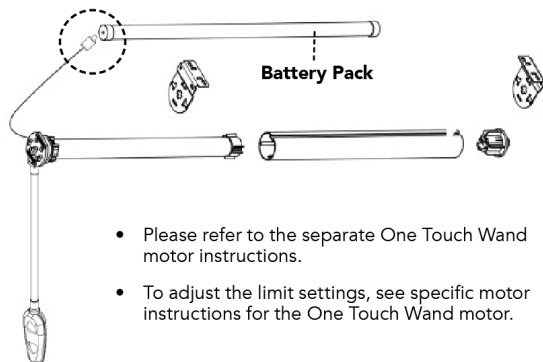

- Please refer to the separate One Touch Wand motor instructions.
- To adjust the limit settings, see specific motor instructions for the One Touch Wand motor.

3D. Finishing the Install Spring Shade

With the shade now installed, you may use your shade.

Note: Initial limits have been set in factory. Use instructions to fine tune.

- Please refer to the separate spring instructions to adjust spring operation.
- Before operating the shade, be sure to first pull out the spring locking pin.
- To test shade operation, tilt the hem bar slightly and pull to raise.

