

INSTRUCTIONS

Designer Free Link Roller Shade

No Headbox

Designer Free Link Roller Shade Installation Instructions

Using two controls, two shades, and a shared intermediate bracket (No Headbox)

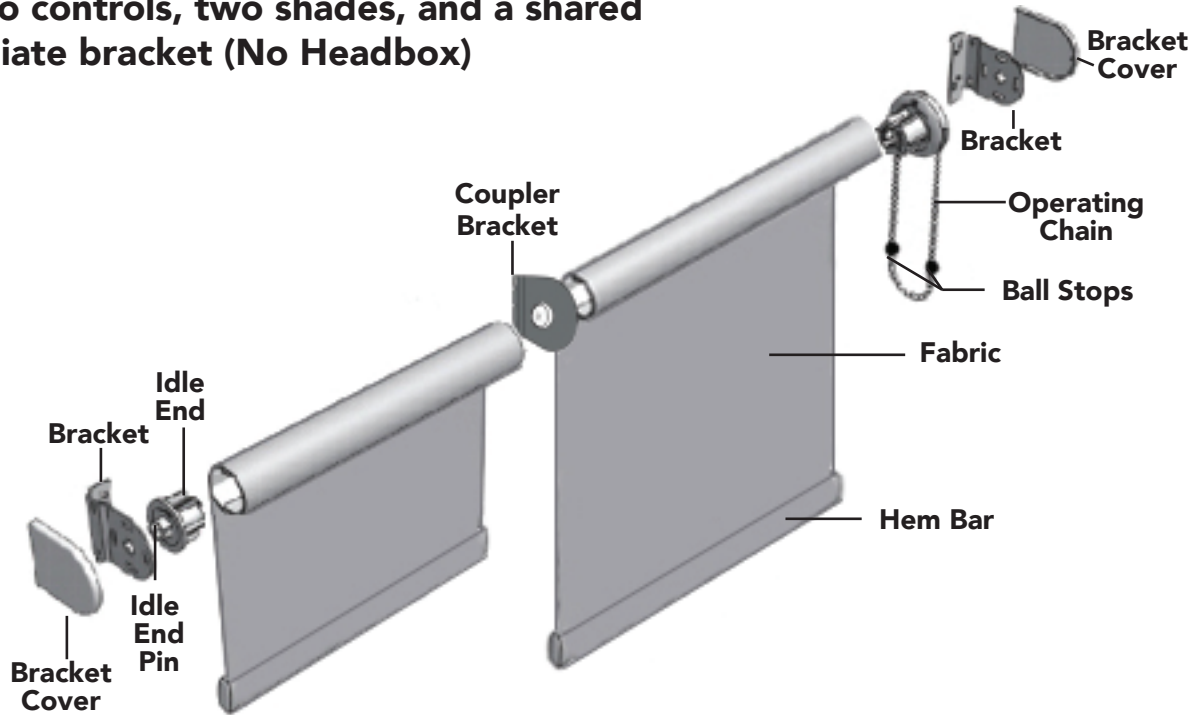

Getting Started

We recommend reading through these instructions before starting the installation. Carefully unpack your shades and check to make sure you have the following installation parts.

Packaged Contents:

- Screws (4)
- Mounting brackets (2)
- Tension device (child safe)
- Bracket covers (2)
- Ball stops (2) (if clutch operated)
- Coupler bracket

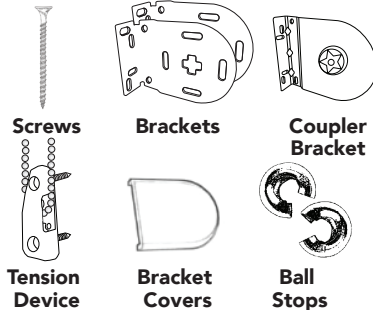

Tools Needed:

- Drill with a 1/8" bit & Phillips head bit
- Phillips screwdriver
- Metal tape measure
- Needle nose pliers
- Level

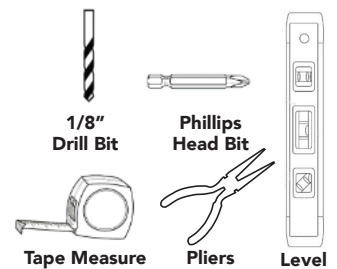

Important Note:

According to the Window Covering Manufacturers Association Inc., all labels must not be removed from the product.

Please note that your brackets must be securely attached to the mounting surface. If your screws do not hit wood studs you will need to use a different fastener which can be found at any local hardware store.

To comply with Child Safety Standards, all tension devices must be installed per the installation instructions provided.



SPECIFICATION SUBMITTAL

Job Name: <input style="width: 90%;" type="text"/>	Model Numbers: <input style="width: 95%;" type="text"/>	
Job Number: <input style="width: 80%;" type="text"/>	<input style="width: 95%;" type="text"/>	<input style="width: 95%;" type="text"/>

INSTRUCTIONS

Designer Free Link Roller Shade

Installation

1). Before Your Install

Measuring For A Free Link System
(Using Clutch or Motor Control)

Measurements

- A). Measure your window in the normal way ($W1 + W2$) and define the desired intermediate point measurement. Noting all measurements.
- B). Measure your drop ($D1$ & $D2$).

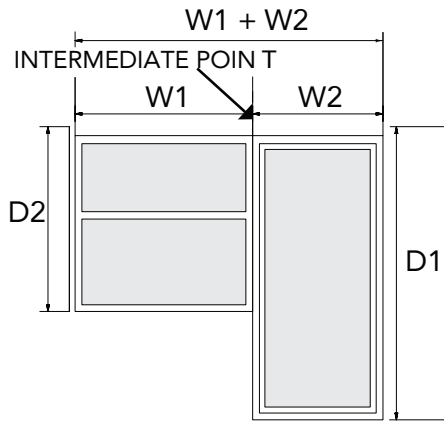

2). Installing the Brackets

- A). Starting at the right hand side, place and secure a control end bracket at the measurement taken.

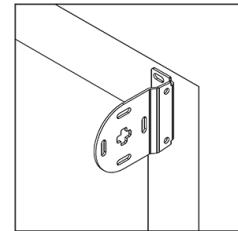

- B). Place a coupler bracket at the intermediate point approximately $1/16''$ less than the size taken, ensuring the central face of the intermediate bracket lines up accordingly.

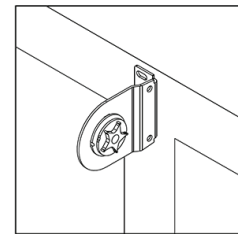

3). Installing the Brackets Cont.

- C). Install control end bracket at the left hand side.

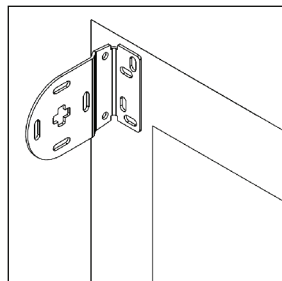

4). Installing the Brackets Cont.

Right hand shade

- A). Insert coupling plunger end through the coupler bracket.

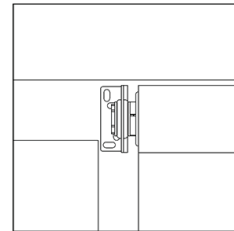

- B). Locate, insert and secure control end.

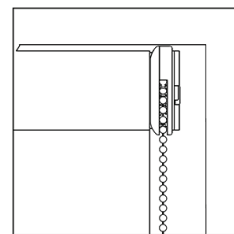

LuXout Shades

SPECIFICATION SUBMITTAL

Job Name:	Model Numbers:	
Job Number:		

INSTRUCTIONS

Designer Free Link Roller Shade Installation

5). Installing Middle Shade Of Three Panels

A). Insert coupling plunger end through the coupler bracket.

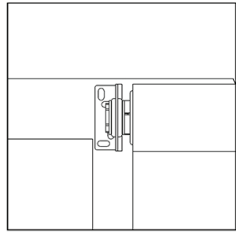

B). Depress the coupling plunger and then locate and secure fixed end into adjacent shade.

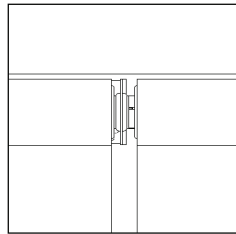

6). Installing the End Shade

Left hand shade

A). Fix the same way as right hand shade. Locate, insert and secure control end.



B). Insert the coupling plunger through the coupler bracket.

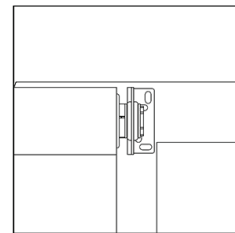

7). Adjusting the Shade

A). Adjust the shade to be level with the control shade. Depress the coupling plunger until the shade is free to turn, (drive connector and coupling fixed end disengage) turn shade until bottom bars are level.

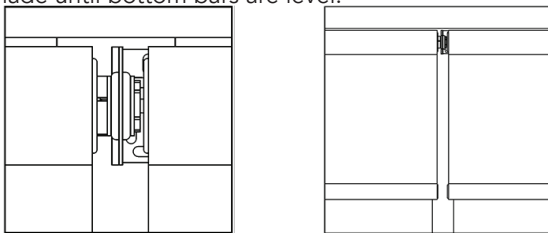

B). Lock the coupling fixed end back into the drive connector.

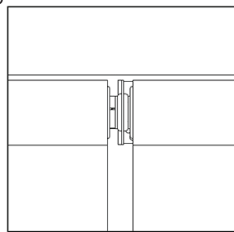

8). Removing Shades

IMPORTANT NOTE: WHEN REMOVING SHADES, SHADES MUST BE REMOVED FROM THE IDLE END ONWARDS. The shades must be removed in order from the idle end side first or shades will drop.

9). Operating Shades

For a conventional designer manual roller shade, in order to lower the shade, pull the rearmost length of chain downwards with a smooth and steady pressure. To roll the shade up do the same on the front length of chain.

For a reverse roll shade the opposite is true, to lower use the front chain and to raise, use the rear chain.

INSTALLER: Please ensure the child safety tag is fitted on the product.

LuXout Shades

SPECIFICATION SUBMITTAL

Job Name:	Model Numbers:	
<input style="width: 90%;" type="text"/>	<input style="width: 30%;" type="text"/>	<input style="width: 60%;" type="text"/>
Job Number:	<input style="width: 30%;" type="text"/>	<input style="width: 60%;" type="text"/>

INSTRUCTIONS

Designer Free Link Roller Shade Installation

9). Finishing the Install

Manual chain operated shade

With the shade now installed, mount the chain tensioner.

- A).** Mount the chain tension device (refer to separate instructions provided with the chain tension device).
- B).** Pull the chain to move the shade to the desired closed position (Note the side being pulled).
- C).** On the opposite side, place a ball stop on the bead closest to the clutch. Use needle nose pliers to clamp ball stop in place.
- D).** Pull the chain to move the shade to the desired open position (note the side that is being pulled).

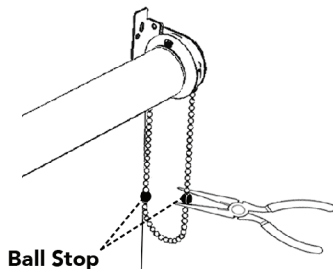

- On the opposite side, place a ball stop on the bead closest to the clutch. Use needle nose pliers to clamp ball stop in place.

10). Installing the Tension Device (Continuous Loop Control)

Consider Position of Tension Device:

The tension device should be positioned on the window frame or the wall so that the tension device and bead chain do not interfere with operation of window treatment.

- A).** The tension device should be installed so that the bead chain is taut without stretching or pulling on it.
- B).** Stretching the bead chain will cause excessive wear.
- C).** Do not twist or cross the bead chain.

**Please refer to Chain Tension Device
Installation Instructions**

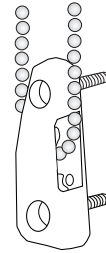

11). Finishing the Install

Motorized Shade

With the shade now installed, you may check the preset limits of your shade.

NOTE: Initial limits have been set in factory. Use the motor controller instructions to fine tune.

- A).** Please refer to the separate motor instructions that are specific to your motor.
- B).** Power-up the motor if not a rechargeable battery motor. Rechargeable battery motors are charged in the factory.

11). Finishing the Install Continued Motorized Shade

C). Set the upper and lower limits to desired levels if not already set correctly or need adjustment.

D). Setup motor shade controls. (initial setup is done at the factory with each shade in a room assigned to a different channel for individual control or grouped as you select. Each channel has a blue LED light. All shades with an LED light will operate when using the controller.)

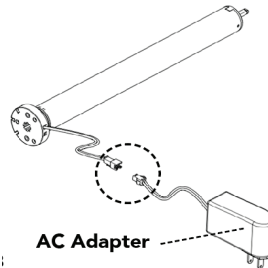

See channel guide for each controller.



SPECIFICATION SUBMITTAL

Job Name: <input style="width: 90%;" type="text"/>	Model Numbers: <input style="width: 60%;" type="text"/> <input style="width: 35%;" type="text"/>
Job Number: <input style="width: 150px;" type="text"/>	<input style="width: 60%;" type="text"/> <input style="width: 35%;" type="text"/>