

# INSTRUCTIONS

## LuXout Shade Controller Programming Instructions

### 5-CHANNEL CONTROLLER

#### 1. FUNCTIONAL OVERVIEW



The LuXout 5-Channel Controller features a contemporary design and wire-free deployment making it retrofit ready for any location. Perfect for all internal motorized shade control applications, it can be mounted on any surface - wall or optional tabletop pedestal. The slim profile eliminates the need for any holes to be cut in the walls.

- FEATURES:**
- Retrofit-Ready
  - Individual and/or Group Control
  - Compatible with Screwless Decorator Wall Plates
  - Functions as a Handheld or Optional Tabletop Controller

#### PACK CONTENTS

- Remote (1)
- Wall Fixing Screws & Anchors (2)
- Mountable Magnetic Holder (1)
- Instruction Manual (1)
- 3V - CR2430 Battery (installed) (1)
- White Single Gang Decorator Wall Plate (1) (including 2 Mounting Screws)
- Pre-programmed Guide

\* OPTIONAL Tabletop Pedestal (if ordered)

#### TOOLS NEEDED:

- Phillips Head Screwdriver
- Flat Head Screwdriver

#### Important Note:

One 5-channel controller is provided for each room with your order. One rechargeable battery charger is also provided for each room of shades with rechargeable battery motors.

# INSTRUCTIONS

## LuXout Shade Controller Programming Instructions

**Fig. 1**

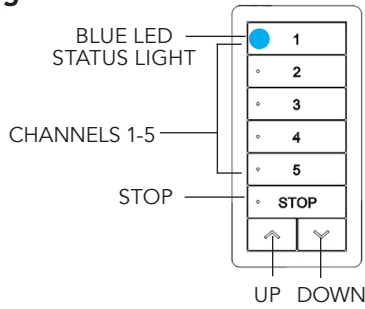

**Fig. 2**

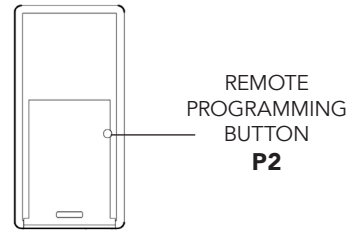

**Fig. 3**

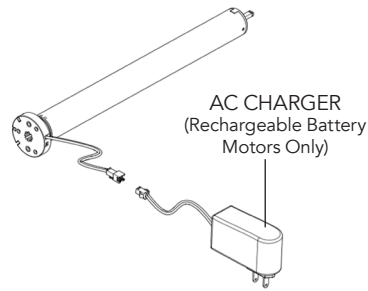

**Fig. 4**

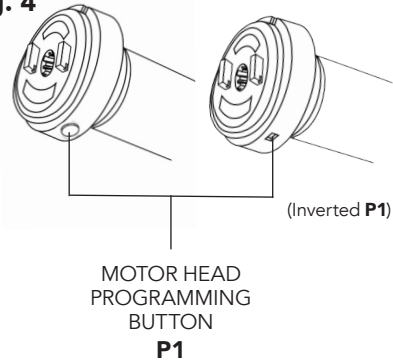

### DIMENSIONS

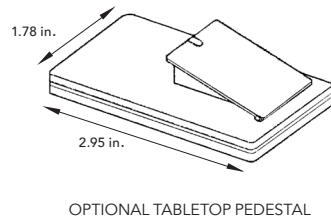
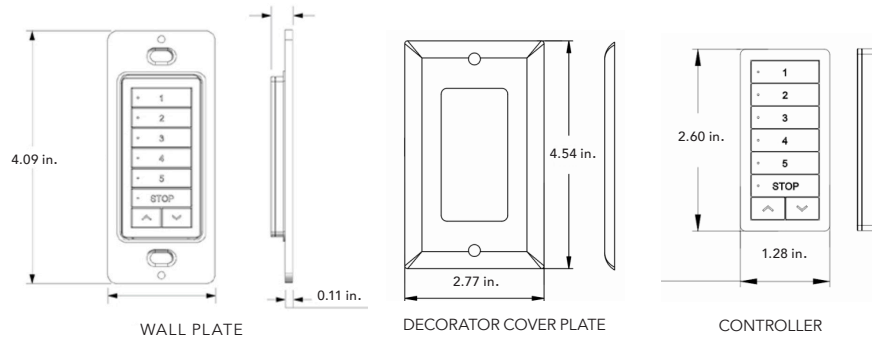

### TECHNICAL SPECIFICATIONS

Input Voltage	3V (CR2430)
Transmitting Frequency	433.92 MHz
Transmitting Power	10 milliwatt
Operating Temperature	-10°C - 50°C
Transmitting Distance	up to 75 feet

# INSTRUCTIONS

## LuXout Shade Controller Programming Instructions

### 2. QUICK START GUIDE

#### QUICK START

1.

Each motorized shade from LuXout Shades comes pre-programmed from the factory. The pre-programming assures the controller is paired with the motor(s) in a room, the upper and lower limits of the shade are set, and the motor is in sleep mode.

2.

After installing the shade, wake up the motor by pressing and releasing the **Program Button (P1)** (**Fig. 4**) on the motor head. Once the **P1** button has been pressed, the shade will move to its lower limit indicating that the shade is now awake.

3.

Once all shades are awake, the LuXout Controller is pre-programmed with one shade per channel button (or one group of shades per channel button\*). Press the **first button #1**, and the **blue LED** will light. Press the **"UP"** arrow button and the shade will move (**Fig. 1**) to its upper limit and stop at the top of the window.

4.

Repeat step 3 for each button.

5.

To operate multiple shades or groups, press each channel desired and the blue LED will indicate each channel selected (**FIG. 1**).

6.

It is important to note that one channel will always be in enable mode.

\* A group can be one or multiple shades per button.

# INSTRUCTIONS

## LuXout Shade Controller Programming Instructions

### 3. INSTALL AND/OR REPLACE CONTROLLER BATTERY

The battery comes installed when shipped with shade.

- a.** Open rear battery cover by gently separating switch covers with a flathead screwdriver.



- b.** Install CR2430 battery with positive side facing up. Snap covers back together.

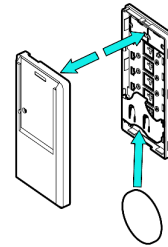

### 4. CHARGING SHADES

For rechargeable battery motors (Fig. 3 - see inside cover page)

This motor has a 12V built-in Li-ion battery pack with integrated charge management. Max power input for recharging: 12.6V/1000mAh

- During operation, if voltage drops to less than 10V, the motor will beep 10 times to prompt when it needs to be charged.
- Motor will stop running when the voltage is lower than 7V and will resume again when the voltage is greater than 7.5V.
- When charger is plugged in, a red LED light indicates the motor is currently charging. A green LED light indicates that battery is fully charged.



- Ensure cable is kept clear of fabric.
- Ensure antenna is kept straight and away from metal objects.

### 5. MOUNTING INSTRUCTIONS

Use the supplied fasteners and anchors as needed to attach the base.

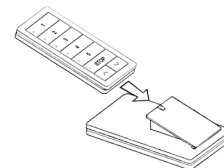
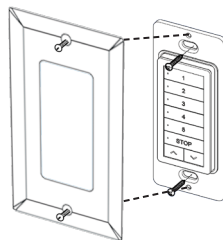

Slide controller into base.

**Best Practice Tip:** To insure best performance, program controller to motors prior to installation at the location the controller will be located. Then test radio performance for that location.



- The 5-Channel Controller is magnetized and can be removed for hand held operation.

# INSTRUCTIONS

## LuXout Shade Controller Programming Instructions

### 6. INITIAL SET UP

#### 6.1 PAIR MOTOR WITH CONTROLLER

Controllers purchased with shades already have the controller paired to the motor.

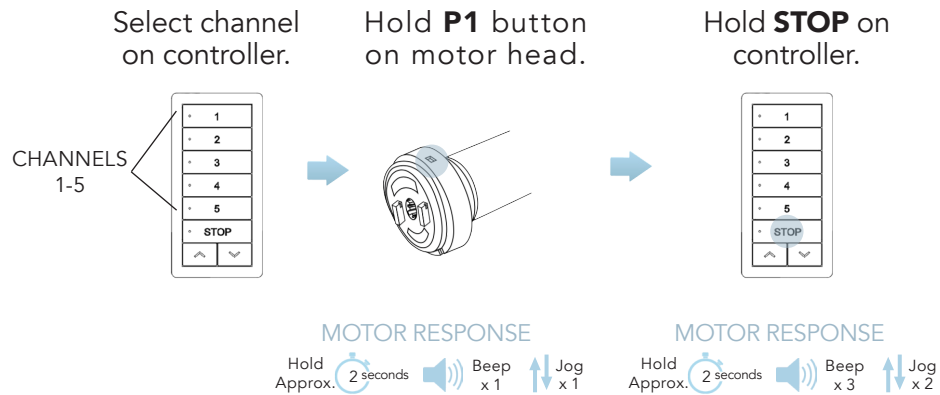

#### 6.2 CHECK MOTOR DIRECTION

This has been done in factory prior to shipment.

To check travel direction of shade, press **UP** or **DOWN** on controller.

To reverse shade direction, hold both **UP** and **DOWN**.

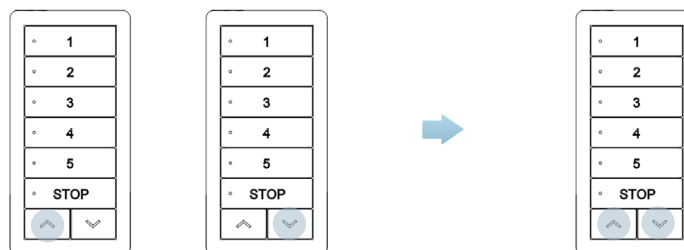

- Quick Press = Step
- Long Press = Continuous Travel

MOTOR RESPONSE

Hold Approx. 2 seconds
Jog x 1

- ⚠ • Damage to shade may occur when operating motor prior to setting limits. Attention should be given.
- Reversing motor direction using this method is only possible during initial set-up.

# INSTRUCTIONS

## LuXout Shade Controller Programming Instructions

### 7. SETTING AND ADJUSTING LIMITS

Initial limits are set to field measurements provided at time of order.

#### Adjusting Upper Limit - move to existing upper limit

Hold **UP** and **STOP** on controller.

Move shade to the desired highest position by pressing the **UP** or **DOWN** button.

To save upper limit, hold **UP** and **STOP**.

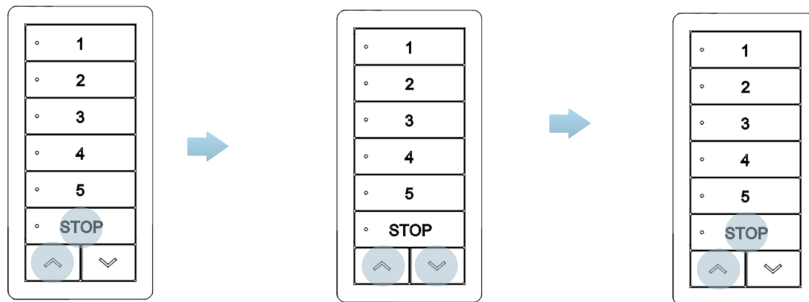

**MOTOR RESPONSE**  
Hold Approx. 5 seconds Beep x 1 Jog x 2

- Quick Press = Step
- Long Press = Continuous Travel

**MOTOR RESPONSE**  
Hold Approx. 5 seconds Beep x 3 Jog x 2

#### Adjusting Lower Limit - move to existing lower limit

Hold **DOWN** and **STOP** on controller.

Move shade to the desired lowest position by pressing the **DOWN** or **UP** button.

To save lower limit, hold **DOWN** and **STOP**.

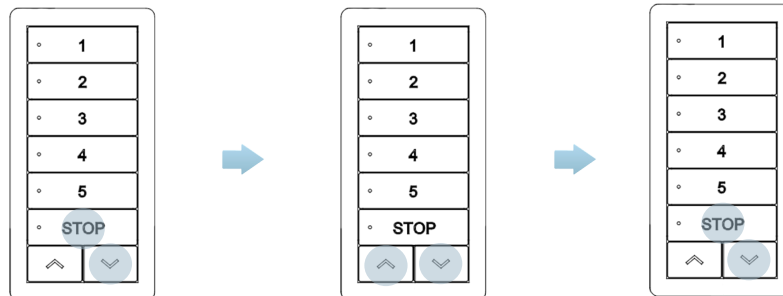

**MOTOR RESPONSE**  
Hold Approx. 5 seconds Beep x 3 Jog x 2

- Quick Press = Step
- Long Press = Continuous Travel

# INSTRUCTIONS

## LuXout Shade Controller Programming Instructions

### 8. FAVORITE POSITION

#### 8.1 Setting Favorite Position

Move shade to the desired position by pressing the **UP** or **DOWN** button on the controller and stop shade at the favorite position.

Using the programming stylus tool (included) press **P2** on controller.

Press **STOP** on controller.

Press **STOP** on controller again.

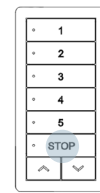
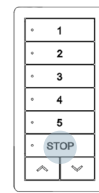
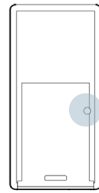
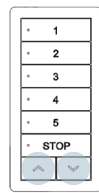

MOTOR RESPONSE



MOTOR RESPONSE



MOTOR RESPONSE



#### 8.2 Deleting Favorite Position

Press **P2** on controller.

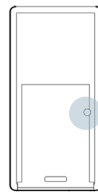

MOTOR RESPONSE



Press **STOP** on controller.

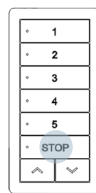

MOTOR RESPONSE



Press **STOP** on controller.

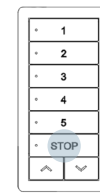

MOTOR RESPONSE



#### 8.3 Using Favorite Position

Hold **STOP** on controller.

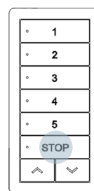

Hold Approx. 2 seconds

# INSTRUCTIONS

## LuXout Shade Controller Programming Instructions

### 9. ADDING AND REMOVING CONTROLLERS & CHANNELS

**A = Existing controller or channel (to keep)**  
**B = Controller or channel to add or remove**

**A.** Select channel that operates motor on existing controller.

**B.** Press P2.

**A.** Press P2 on existing controller again.

**A.** Select desired channel on new controller.

**B.** Press P2.

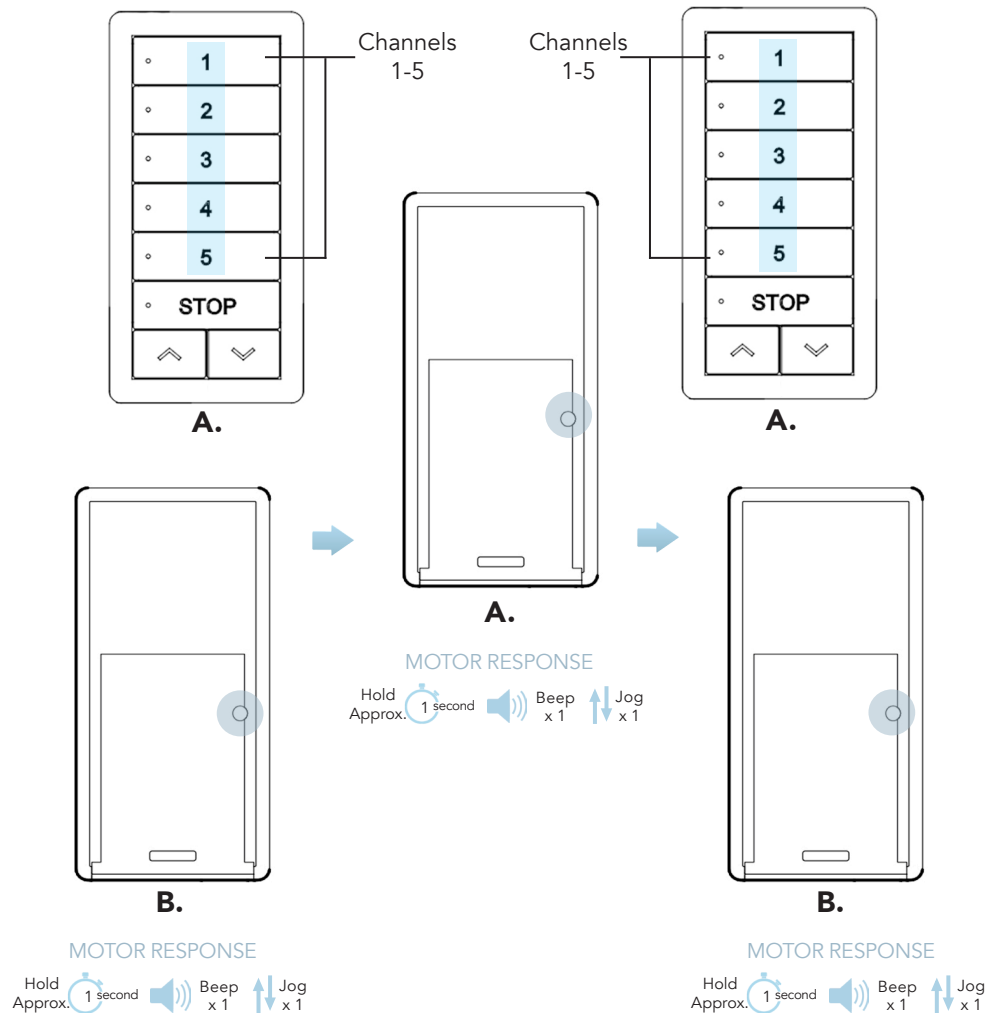



# INSTRUCTIONS

## LuXout Shade Controller Programming Instructions

### 10. ADJUSTING MOTOR SPEED

#### 10.1 Increase Motor Speed

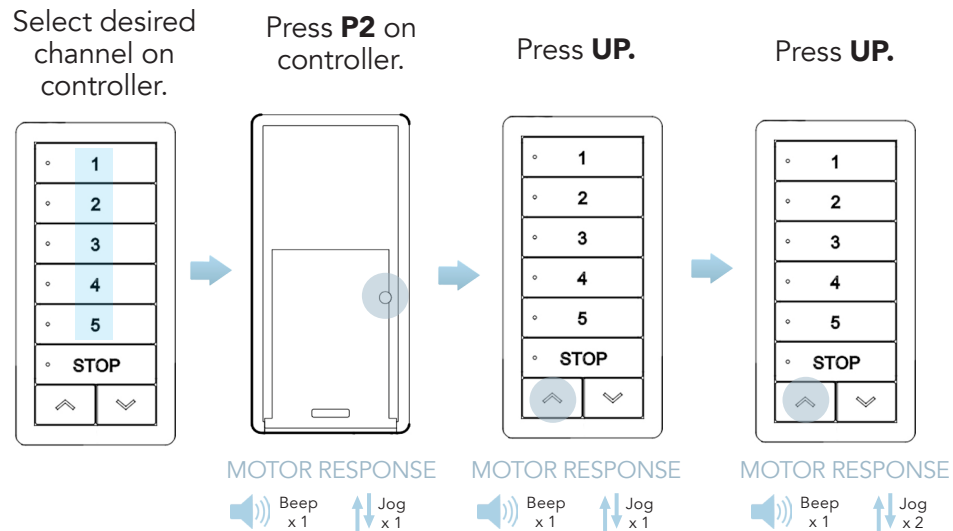

#### 10.2 Decrease Motor Speed

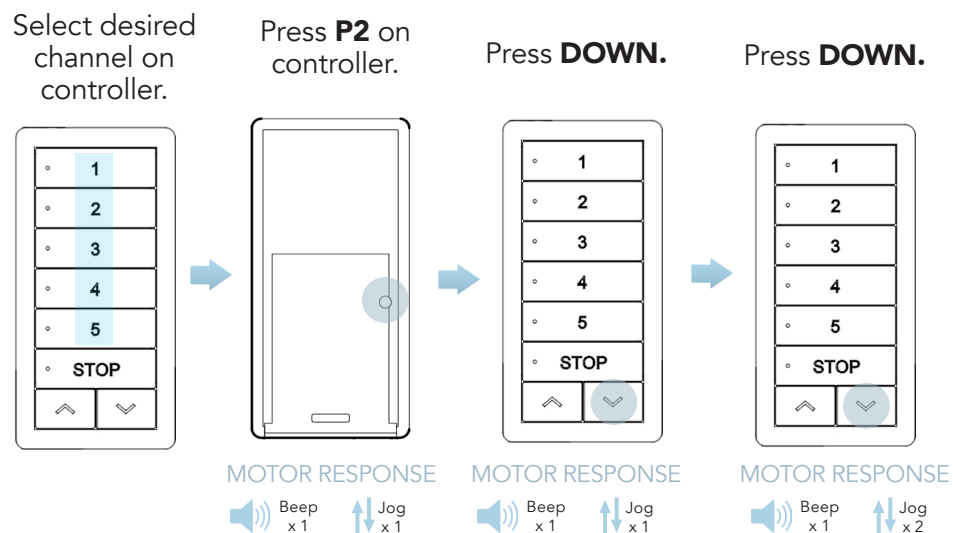

#### **!** IMPORTANT

If motor does not react to speed adjustment, the maximum or minimum speed has already been reached. There are only 3 speeds: slow, medium and fast.

# INSTRUCTIONS

## LuXout Shade Controller Programming Instructions

### 11. TROUBLESHOOTING

PROBLEM	CAUSE	REMEDY
Motor is not responding	Switch battery is discharged	Replace battery
	Battery is inserted incorrectly	Check battery polarity
	Radio interference/shielding	Ensure controller is positioned away from metal objects and that antenna on motor or receiver is kept straight and away from metal.
	Receiver distance is too far from controller	Move controller to a closer position.
	Power failure	Check power supply to motor is connected and active.
	Incorrect motor plug-in wire connection	Check that wiring is connected properly
	Motor still in sleep mode	If motor is in sleep mode (we ship shades in sleep mode to protect shade) press the P1 button on the motor. Shade will move.
Cannot set limits on a single motor (multiple motor response)	Using "group" channels to adjust single motor limits	Put motors that do not need adjustment into sleep mode. Recharge motor by pressing the P1 button until you get 2 jogs. If a plug-in motor, unplug motors not needing adjustment. Then adjust limits per section 7 (page 7).
Motor will not go down after setting the top limit.	Top limit was set using the <b>DOWN</b> and <b>STOP</b> buttons.	Reset the motor and lower limit. <b>Remember</b> that upper limit is to be set using the <b>UP</b> and <b>STOP</b> buttons, and the down limit is set using the <b>DOWN</b> and <b>STOP</b> buttons.